



**TRANE™**

# CGWD CCUD

Liquid chillers, water cooled  
or remote air cooled.

Two independent circuits.

- Fitted with a microprocessor-based leaving chilled water temperature controller.
- Extensive remote control and communication capabilities.
- Nominal cooling capacities 135 kW to 601 kW (50 Hz), 11 unit sizes.
- Two independent refrigerant circuits.
- All water cooled models factory run tested.
- Model CGWD with built-in, water cooled condensers, model CCUD for use with remote air cooled condenser.
- Designed and manufactured in accordance with Trane Quality Management System approved to BS 5750, Part 1.

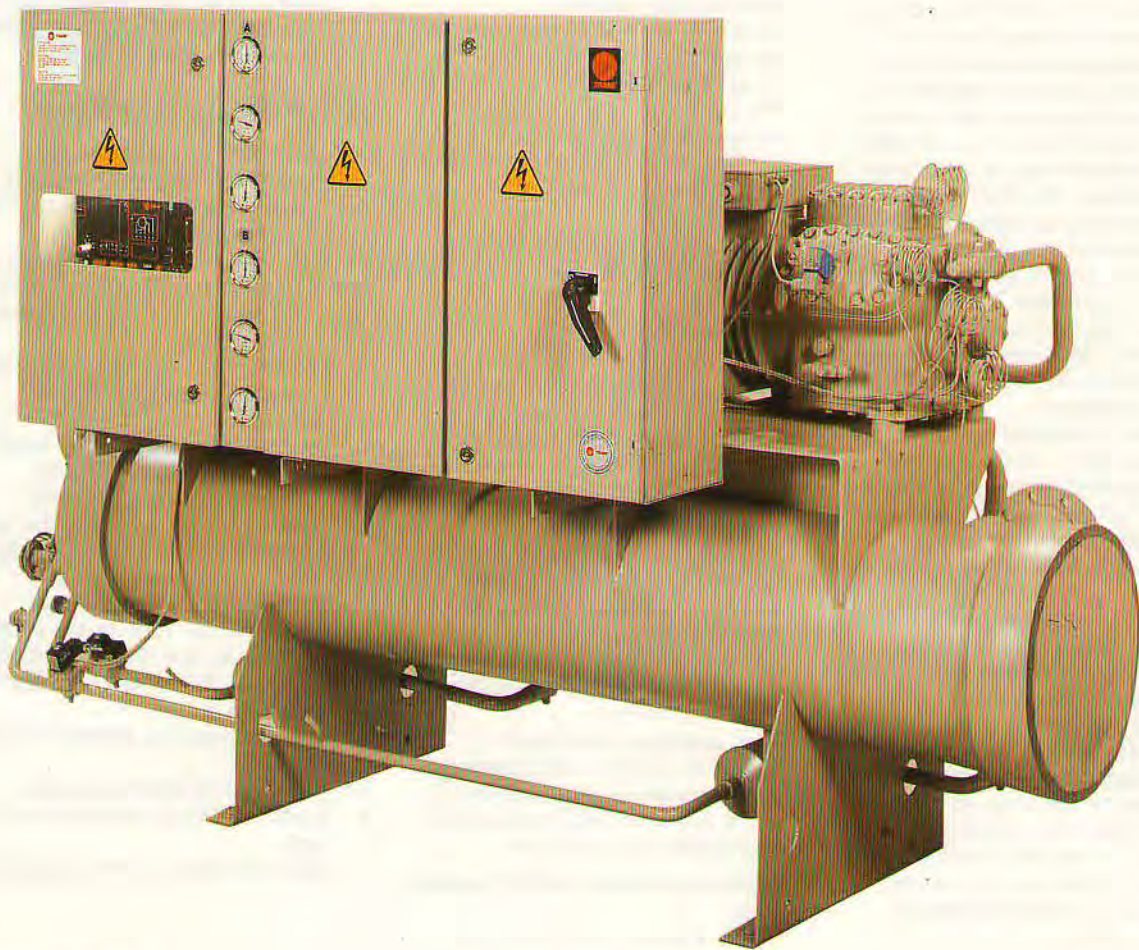

B45 CA 001 E

Dual circuit reciprocating liquid chillers, water cooled or remote air cooled.  
Series CGWD and CCUD 135 kW to 601 kW (50 Hz).

# T

he new Trane CGWD reciprocating liquid chillers make use of proven components which have contributed to establish the reputation of superior reliability and performance of the Trane reciprocating chillers.

The Trane water chillers type CGWD and compressor chillers type CCUD are equipped with the latest microprocessor control technology. Microprocessor chiller control means smooth, accurate and logical chiller control. That translates into even greater reliability and chiller performance. All unit sizes are exceptionally compact and fully accessible for service and maintenance.

The liquid chillers are available with built-in water cooled condensers or without condenser for use with a remotely installed air cooled condenser. All water cooled chillers are fully factory run-tested before shipment.

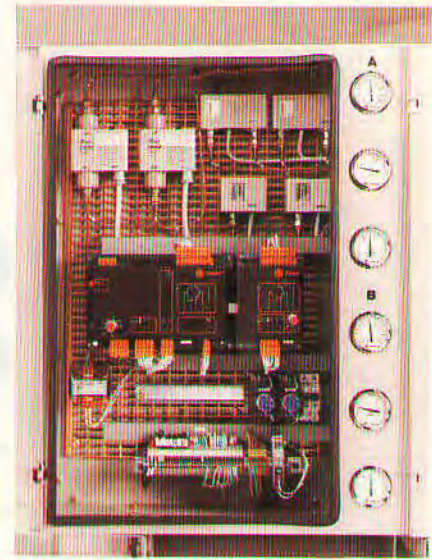

## Control module specifications

### Microprocessor based chilled water control

The RCM controls from the leaving or supply water side of the chiller. With this temperature as a component of input, its programmed logic establishes the appropriate control response needed to produce a stable and accurate leaving water temperature condition. The PID (proportional plus integral plus derivative) control action works as follows : Proportional control produces a degree of compressor loading or unloading that is proportional to the difference between the leaving water temperature and the set point temperature.

This is where integral control action takes over ; so long as the temperature difference persists, the controller integrates the error over time and continues to load or unload the compressor, as necessary, in an effort to return the temperature to the set point. Integral control looks backwards in time, therefore it cannot anticipate the need for future control action. The derivative function anticipates future control action by taking into consideration the rate of temperature change or the slope of the change. If the slope is steep, the compressor is loaded or unloaded at a fast rate. If the slope is shallow, the loading or unloading rate is reduced.

PID control produces accurate, responsive control action, eliminating steady state error from the chiller leaving water temperature.

### Operating mode control

- **Anti-recycle timing**  
Based on time between compressor starts, this provides operational stability. Before stopping the lag compressor running on its last capacity stage, the RCM control module unloads the first capacity step of the lead compressor.  
In this way, excessive compressor cycling at 50 percent load is avoided.
- **Load limiting**  
After starting the chiller, the last compressor step is loaded only when the leaving chilled water temperature falls below the preset point, thus preventing nuisance motor overload trips.
- **Periodic pump-down**  
During shut-down periods, evaporator pressure is checked hourly. If the pressure rises above a safety limit, a pump-down cycle is initiated. Periodic pump-down avoids liquid slugging at start-up.
- **Low pressure start logic**  
When the chiller is started, the low pressure signal is ignored for 3 minutes until pressures in the chiller are stabilized.
- **Automatic restart after a power loss**  
After a power loss, the module automatically restarts the chiller, provided no fault condition is detected.

- **Operating time balancing**  
Each time the chiller stops, the RCM module automatically reverses the compressors starting order, thus balancing operating time on each circuit.

### System protection

All the safety parameters are checked before the chiller starts and during chiller operation. If one of the following problems is detected the RCM module stops the chiller and provides trouble shooting information via LEDs located on its front cover.

- Chilled water set point too close to low temperature cutout setting.
- Malfunction of the RCM module.
- Low leaving chilled water temperature. This prevents freezing while avoiding the nuisance of low temperature trips.
- Water temperature sensor is defective or short circuited.
- Loss of water flow in the evaporator. Only the relevant circuit is shutdown if one of the following problems occurs :
- Low evaporating pressure below set point.
- Oil pressure below set point.
- Motor winding temperature too high.
- Motor current drawn too high.

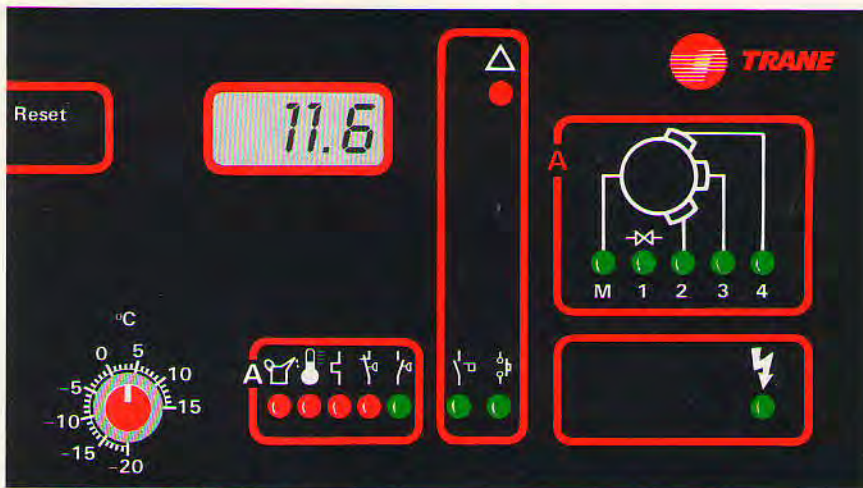

RCM Base Module (Circuit A)

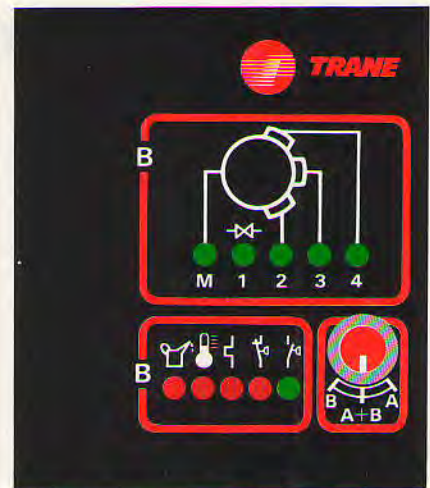

RCM Extension Module (Circuit B)

## Communication

The RCM module offers several possibilities of communication. These different systems of communication considerably simplify the fault diagnostic and provide status information.

### Operator interface

The RCM module has a display board with LEDs providing the following information:

- Compressor loading status.
- Evaporator water pump on.
- Control power supply on.
- Safeties satisfied (oil pressure, motor temperature, condensing pressure...).

Should a safety device trip out, the corresponding fault indicating LED and the general fault LED are energized.

When the defect is repaired the reset button must be depressed to enable the chiller to restart. The leaving chilled water temperature set point can be adjusted on the face of the RCM module.

### Remote control and communication interface

The RCM module is equipped with terminal strips for the connection of the following inputs:

- Remote On/Off control by means of a potential-free contact.
- Remote chilled water reset through an analogical input (0 to 10 volts).

Optional relay cards — one per circuit — can be connected to the RCM module providing potential free contacts for remote status and failure indication:

- Chiller ready for start.
- Machine (circuit) in operation.
- Oil pressure trip-out.
- Freeze protection trip-out.
- Motor winding temperature trip-out.
- Condensing pressure trip-out.
- Motor overload trip-out.

### Remote control through a serial link

The RCM module is fitted with a serial communication connection which allows the chiller to be integrated in a Building Management or Automation System. All information required to control the chiller from a remote location is converted into binary signals and transmitted through a serial communication link.

Up to 16 chillers can be connected to the same link.

The RCM module uses a TTY type serial communication link. This link is compatible with almost all B.A. Systems available on the market. Its sensibility to interferences is very low, transmission speed reaches 4800 bauds. The maximum length of the link is 1500 meters. The RCM is a "slave system" controlled from the higher level Build-

ing Automation System which can send the following commands:

- Change of the chilled water set point.

- Start or stop the chiller.

The B.A. System can also extract from the RCM such information as:

- Chilled water set point.
- Freeze protection set point.
- Leaving chilled water temperature.
- Number of loaded capacity steps.
- Hot gas bypass in operation (chillers equipped with hot gas bypass only).

Should the unit trip out on a safety device:

- Type of fault.

The information obtained through the serial link can be displayed on a computer control monitor.

The local Trane sales office will provide the protocol specification upon request.

### Cooling capacities and power input (50 Hz)

Model	Evap. leaving water temp. (°C)	Condenser leaving water temperature (°C)							
		30		35		40		45	
		Cooling (kW)	Input (kW)	Cooling (kW)	Input (kW)	Cooling (kW)	Input (kW)	Cooling (kW)	Input (kW)
205 Z	5	129.5	29.8	123.2	31.9	116.2	34.2	108.5	36.5
	7	137.9	30.4	131.1	32.7	123.7	35.1	115.8	37.4
	9	146.6	31.1	139.4	33.5	131.5	36.0	123.3	38.4
206 Z	5	151.2	35.1	144.0	37.4	136.3	39.8	128.1	41.9
	7	161.0	35.8	153.4	38.3	145.3	40.8	136.8	43.2
	9	171.1	36.5	163.0	39.1	154.6	41.7	145.8	44.3
207 Z	5	190.3	43.9	179.9	46.6	169.6	49.5	159.3	52.4
	7	203.6	44.7	192.7	47.7	181.9	50.8	171.0	53.9
	9	217.4	45.5	206.2	48.7	194.9	51.9	183.2	55.4
208 R	5	240.6	56.5	228.4	60.7	216.3	64.5	203.4	68.2
	7	256.5	57.7	244.0	61.3	231.2	65.4	218.1	69.2
	9	272.8	58.8	260.2	63.4	247.1	67.7	233.4	71.9
2X9 R	5	267.4	61.5	254.2	66.1	240.7	70.3	226.9	74.3
	7	284.4	62.6	270.9	67.3	257.1	71.8	242.8	76.0
	9	302.0	63.6	288.2	68.6	274.0	73.4	259.2	77.9
209 R	5	305.1	68.0	290.0	73.0	274.6	77.6	258.6	82.0
	7	324.3	69.1	309.0	74.3	293.0	79.3	276.4	84.0
	9	344.2	70.1	328.5	75.6	312.0	80.8	294.8	85.8
210 R	5	330.8	74.8	315.3	80.5	299.3	85.8	282.9	90.7
	7	350.8	75.9	334.9	81.7	318.4	87.4	301.3	92.7
	9	371.4	76.9	355.0	83.0	337.9	89.0	320.2	94.7
211 R	5	365.6	82.9	348.9	89.2	331.6	95.3	313.8	100.9
	7	387.3	84.1	369.9	90.6	351.9	97.0	333.4	103.1
	9	409.5	85.2	391.3	92.0	372.6	98.7	353.4	105.2
213 E	5	435.7	89.4	412.9	96.3	390.2	102.8	367.6	109.0
	7	463.9	90.7	440.2	98.1	416.5	105.1	392.8	111.7
	9	493.0	92.0	468.3	99.8	443.7	107.2	419.0	114.3
214 E	5	501.5	102.3	476.8	110.2	451.8	117.9	426.6	125.1
	7	533.2	103.7	507.7	112.0	481.9	120.3	454.7	128.0
	9	565.9	104.8	539.7	114.0	512.9	122.7	485.8	130.9
215 E	5	575.8	116.4	548.6	125.7	520.8	134.6	492.4	142.9
	7	611.8	118.0	584.0	127.9	555.5	137.3	526.0	146.2
	9	648.8	119.5	620.6	129.8	591.3	139.8	560.8	149.4

Evaporator water side pressure drop

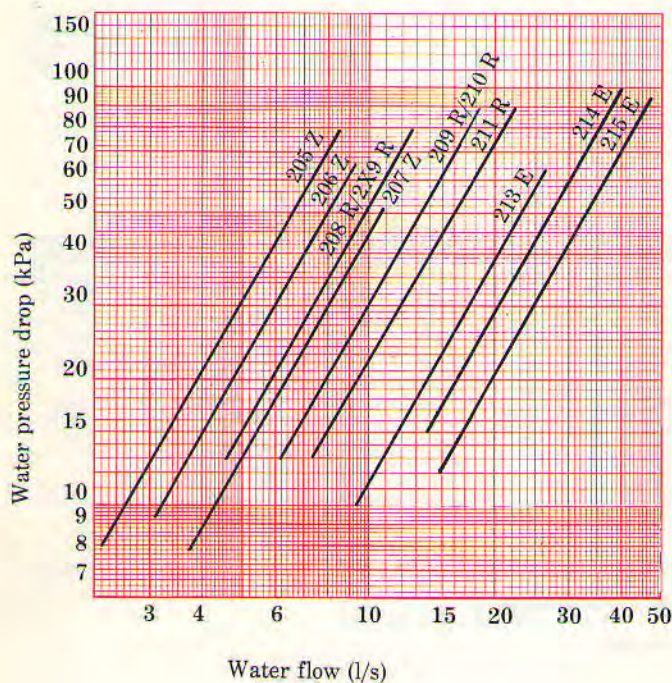

Condenser water side pressure drop

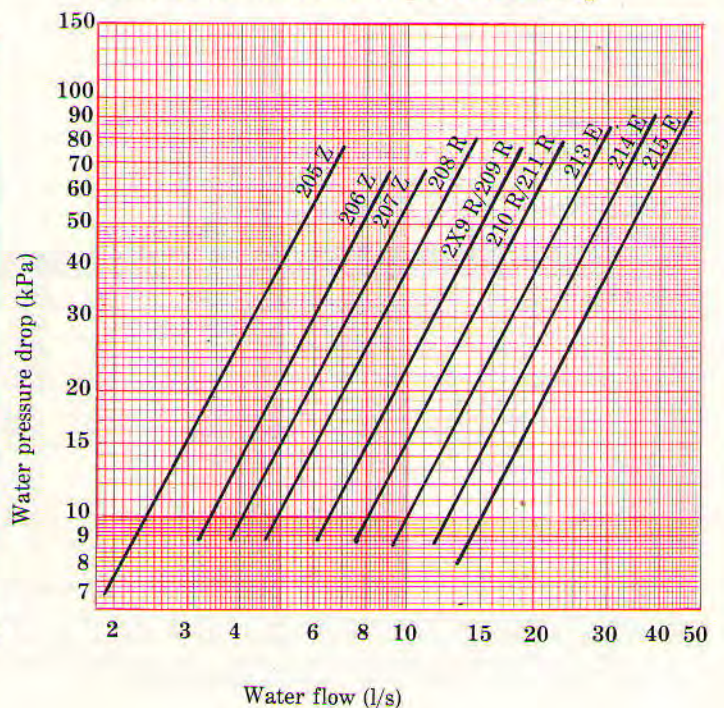

## Electrical and general data (50 Hz)

Model	CGWD	205 Z	206 Z	207 Z	208 R	2X9 R	209 R	210 R	211 R	213 E	214 E	215 E
No of compressors/circuits		2/2	2/2	2/2	2/2	2/2	2/2	2/2	2/2	2/2	2/2	2/2
Capacity steps	%	75-50-25	75-50-25	83-50-33	75-50-25	81-44-22 or 78-55-37	83-50-33	81-44-29 or 85-55-37	83-50-33	75-50-25	71-43-21 or 79-57-29	75-50-25
Rated load amps (2)	A	74	90	112	162	166	170	191	212	226	267	308
Starting amps (3)	A	144	178	218	333	385	389	443	464	530	744	782
Evaporator water content	l	114	103	102	88	88	164	164	140	188	328	253
Condenser water content	l	22	20	29	32	45	45	52	52	60	62	73
R22 operating charge	kg	30	32	40	48	48	62	62	68	80	108	120
Unit operating weight (4)	kg	1300	1300	1420	1800	1950	2280	2320	2340	2950	3510	3730

(1) At +7°C chilled water leaving and 32°C condenser water leaving temperatures. Standard size heat exchangers.

(2) At 415/3/50 at 5 bar suction pressure, 25 bar discharge pressure.

(3) At part winding start. One compressor at full load, the second one starting. On sizes 2X9 R, 210 R and 214 E the compressor starting is the largest one of the two.

(4) All capacity and weight data apply to the series CGWD units (with built-in water cooled condenser). For series CCUD units (without condenser, for use with remote air cooled condenser) refer to your Trane Sales Office for information.

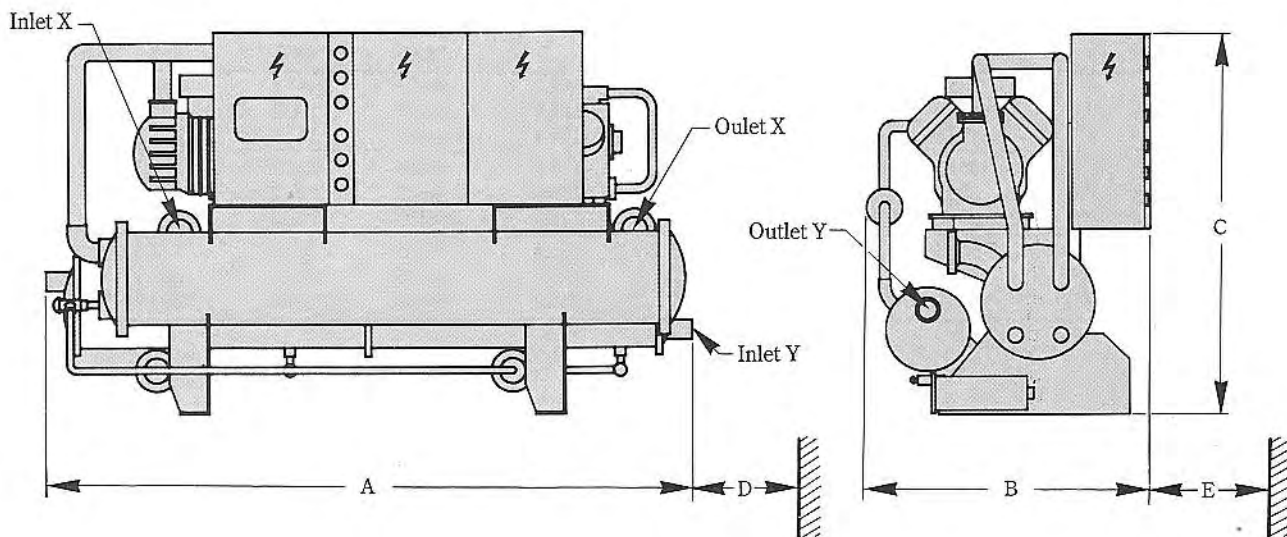

## Dimensions

Model	CGWD	205 Z	206 Z	207 Z	208 R	2X9 R	209 R	210 R	211 R	213 E	214 E	215 E
Length	A (mm)	2080	2080	2250	2400	2400	2840	2850	2850	2880	4050	4050
Width	B (mm)	1050	1050	1070	1220	1220	1270	1360	1360	1220	1370	1370
Height	C (mm)	1700	1700	1700	1750	1750	1750	1800	1800	1850	1850	1850
Tube removal space	D (mm)	2000	2000	2000	2050	2050	2450	2450	2450	2450	4000	4000
Clearance	E (mm)	600	600	600	600	600	600	600	600	600	600	600
Chilled water connection size (1)	X	2½"	3"	3"	3"	3"	4"	4"	5"	5"	4"	4"
Condenser water connection size (2)	Y	2½"	2½"	3"	3"	4"	4"	4"	4"	4"	5"	5"

(1) Flanged connections on all sizes.

(2) Connections female pipe ISO/R7 on sizes 205 Z, 206 Z, 207 Z and 208 R. All other sizes have flanged connections.

(3) Minimum clearance on all four sides 600 mm, recommended clearance for tube removal on the right or left hand side of the unit.

(4) Location of water connections depends on model and size. Refer to certified submittal drawings.

(5) Drawings and dimensions approximate. Certified drawings on request.

# Mechanical specifications

Dual circuit liquid chiller unit, factory assembled and wired, consisting of :

## Compressors

Two semi-hermetic reciprocating compressors with capacity control and reduced load starting. Positive displacement oil pump, oil filter, sight glass and crankcase heater. Suction gas cooled motor protected by winding temperature sensors and external overload relay.

## Water cooled condenser (except series CCUD)

Shell-and-tube design with two separate refrigerant circuits. Steel shell welded to heavy tube sheets. Seamless integrally finned copper tubes mechanically expanded into grooved tube sheets. Built-in liquid subcooler. Removable heads of closed grain cast iron. Water connections female pipe thread ISO R7 on sizes 205 Z, 206 Z, 207 Z and 208 R, flanged connections on all other sizes.

Safety relief valve. Maximum operating pressure refrigerant side 2.5 MPa, water side 1.4 MPa.

## Evaporator

Shell-and-tube design with two separate refrigerant circuits. Refrigerant inside the tubes and water circulating in the shell ; steel shell welded to heavy steel tube sheets. Refrigerant heads of high strength cast steel bolted to the tube sheets. Self-energizing type gaskets requiring low bolt torque. Water connections flanged on all sizes. Thermal insulation of evaporator of flexible closed cell polyvinylchloride. Maximum operating pressure refrigerant side 1.4 MPa, water side 1.4 MPa.

## Control and starter panel

Panel with separate compartments for motor starters and controls. Starter panel section includes : Part-winding motor contactors

- Overload relay
- Terminal strips

Control panel section including Trane RCM microprocessor-based control and communication module providing the following functions :

- Evaporator leaving water PID temperature control
- Control of the operating mode
- System protection
- Communication and remote control

Operator level : LEDs on the front panel of the module provide operating status, fault indication and diagnostics information.

Parallel communication and remote control :

Remote change of set point, and remote on/off control. Optional relay cards provide potential free contacts for seven status and fault indicators per circuit. Serial communication and remote control :

A TTY serial communication port allows binary operating status information and command transmission and integration of the chiller into Building Management Systems.

The control panel section further includes oil pressure, discharge pressure and low pressure pressostats and terminal strips. The RCM module is visible through a window in the control panel access door. Oil pressure, low pressure and high pressure gauges are provided on the panel.

## Two refrigerant circuits

Each circuit including filter-dryer, sight glass, solenoid valve and thermostatic expansion valve. Compressor discharge service valve and liquid line shut-off solenoid valve. Refrigerant circuit factory pressure and leak tested, dehydrated and charged with refrigerant charge.

## Accessories and options

- Rubber-in-shear or spring type isolators.
- Hot gas muffler (standard on CGWD 205 Z to 207 Z).
- Disconnect switch.
- Condenser and evaporator mismatch arrangements.
- Factory-installed hot gas bypass.
- Relay card for remote status and failure indication (one card per circuit).

## Factory testing

CGWD are fully factory run tested. Unit operation and all controls are thoroughly checked out before shipment.

## Shipment.

CGWD ship on a wooden skid with the refrigerant and oil operating charges.

CCUD compressor-chiller units ship on a wooden skid with oil operating charge and refrigerant holding charge.

## Quality Assurance

The Quality Management System applied by Trane has been subject to independent third party assessment and approval to BS 5750 Part 1, I.S.O. 9001, and N.E.N. 2646.

The products described in this catalogue are designed, manufactured, and tested in accordance with the approved system requirements as defined in the Trane Quality Manual.

*Subject to modifications.*

## Sales offices in United Kingdom and Eire

### Birmingham

24, New John Street West,  
Newtown, Birmingham B19 3NB  
Phone : (021) 359 6354/6 - Telex : 336 995 G

### Bristol

Dockgate House, 151 Hotwell Road, Hotwells,  
Bristol BS8 4RU  
Phone : 0272 297761 - Telex : 44241 G

### Dublin

8, The Mall, Lucan, Co. Dublin  
Phone : (0001) 282965 - Telex : 721 472 E

### Glasgow

10 Napier Court, Wardpark North Industrial Estate,  
Cumbernauld G68 0LG  
Phone : Cumbernauld (02367) 36927 -  
Telex : 779 361 G

### London

162, Windmill Road West,  
Sunbury on Thames, Middlesex TW 16 7HB  
Phone : (0932) 780321 - Telex : 927 357 G

### Manchester

Enterprise Trading Estate, Guinness Road,  
Trafford Park  
Manchester M17 1SD  
Phone : (061) 848 0491 -  
Telex : 937400 G (Ref. 29768001)

### Newcastle

218 Rothbury Terrace, Heaton  
Newcastle Upon Tyne NE6 5DF  
Phone : (091) 276 2000 - Telex : 537 259 G

### Nottingham

60, Lenton Boulevard,  
Nottingham NG7 2EN  
Phone : (0602) 412212 - Telex : 377 552 G



**TRANE**™

B 45 CA 001 E - 0288